

# **CARDIO** *Theater*<sup>®</sup>

## **PVS**

(PERSONAL VIEWING SYSTEM)

## **INSTRUCTION MANUAL**



**Important:** read this setup manual before unpacking units.

Cardio Theater Inc.  
Service 1-800-776-6695  
Sales 1-800-CARDIO-1  
[www.cardiotheater.com](http://www.cardiotheater.com)

**CONGRATULATIONS** on your choice of this product. Its superior video and sound reproduction will provide years of enjoyment and entertainment. We appreciate your patronage and take pride in the quality components our company produces. Please read this manual before you install and operate the system. This manual will acquaint you with operating features and system-connection considerations.

**Retain this manual for future reference.**

## Contents

|  |              |
|--|--------------|
| <b>Before You Begin</b> .....                | <b>2</b>     |
| <b>Recommended Tools</b> .....               | <b>4</b>     |
| <b>Important Safeguards</b> .....            | <b>5</b>     |
| <b>Suggestions for Installation</b> .....    | <b>7</b>     |
| <b>Controls and Indicators</b> .....         | <b>8</b>     |
| <b>Attaching PVS Controller</b> .....        | <b>10</b>    |
| <b>PVS Remote Control</b> .....              | <b>11</b>    |
| <b>PVS Video Levels / Distribution</b> ..... | <b>12-14</b> |
| <b>Specifications</b> .....                  | <b>15</b>    |

- Please ensure that you have all of the required equipment before disposing of any packing materials.
- Verify that you have all the proper tools before starting.

## Unpacking

Unpack the units carefully and secure all parts so that none are misplaced. Examine the units for possible damage. If any damage is noticed, notify your dealer immediately. If the system was shipped to you, notify the shipping company without delay. Only the person or company receiving the goods can file a claim against the carrier for shipping damage. We recommend that you retain the original carton and packing materials should you need to transport the system in the future.

PVS 14.1" FLAT SCREEN MONITOR  
STAND



PVS UNIVERSAL PIVOTING



PVS CONTROLLER WITH  
MAXJACK TECHNOLOGY



U-SHAPED  
REAR COWLING & END CAP



PIVOTING

HANDLE



- Please ensure that you have all of the required equipment before disposing of any packing materials.

PVS POWER SUPPLY



PVS REMOTE CONTROL



POWER & COAXIAL CABLE



NEOPRENE

MOUNTING PAD



WIRE  
PVS CONTROL CABLE  
WITH PO34 VOICE COUPLER

TIES &





---

Hex bit set  
T-Handle Set 3mm, 4mm, 1/8", and 3/16"  
Torpedo Level  
7/16" Open-end wrench  
Diagonal Cutters  
Pivot or Straight Driver

---

## Important Safeguards

5

Please read all of the safeguards before operating this unit. Follow all warnings placed on the unit and adhere to the

operating and use instructions. Retain this manual for future reference.

- 1. Power sources** - Connect the unit to a power source only of the type described in the operating instructions or as marked on the appliance.
- 2. Power-cord protection** - Route all power-supply cords so that they are not walked on or pinched by items placed upon or against them.



- 3. Grounding** - Take precautions so that the grounding or polarization means of the unit are not defeated.
- 4. Ventilation** - Position the unit so that its location does not interfere with ventilation. To maintain good ventilation, do not put items on or over the unit. Do not use the unit on a cushioned surface that may block the ventilation openings.

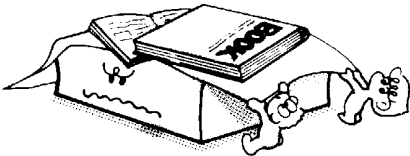

- 5. Water and moisture** - Do not locate the unit near water.

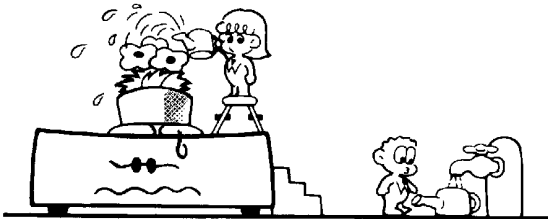

- 6. Temperature** - The unit may not function properly if used at extreme temperatures. The ideal temperature is 41oF (5°C) to 87°F (30°C)

- 7. Heat** - The unit should be located away from heat sources such as radiators, heat registers, stoves, etc.

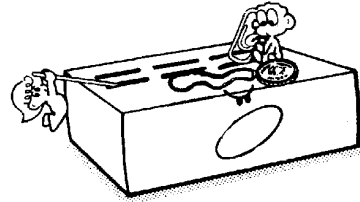

- 8. Electric shock** - Care should be taken so that objects do not fall and liquid is not spilled on the enclosure. If a metal object, such as a hairpin or a needle, comes in contact with the inside of this unit, a dangerous electric shock may result.

- 9. Enclosure removal** - Never open the enclosure. If the internal parts are accidentally touched, a serious shock may occur.

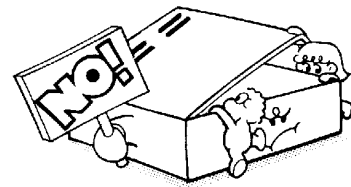

- 10. Cleaning** - Use a clean dry cloth. Do not use solvents such as alcohol; paint thinner, etc. to clean the unit.



- 11. Abnormal smell** - If an abnormal smell is detected, immediately turn the power OFF and disconnect the power cord. Contact your dealer or service center.

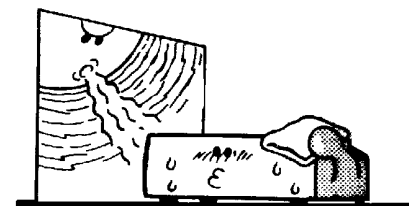
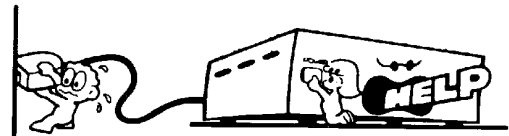

**12. Stands** - Any component stand should be moved with care. Quick or excessive force could cause the stand to overturn.



**13. Nonuse periods** - The power cord should be disconnected when left unused for a long period of time.

**14. Damage requiring service** - The unit should be serviced by a qualified Cardio Theater technician when:

- A. The power cord or the plug has been damaged;
- B. Objects have fallen on, or liquid has been spilled into the unit;
- C. The unit has been exposed to rain;
- D. The unit does not appear to operate normally or exhibits a marked change in performance;
- E. The unit has been dropped or the enclosure damaged.

**15. Servicing** - The user should not attempt to service the unit beyond that described in this manual. All other servicing should be referred to a qualified technician.

## Safety Precautions

**WARNING: TO PREVENT FIRE OR ELECTRIC SHOCK, DO NOT EXPOSE THIS APPLIANCE TO RAIN OR MOISTURE.**



**CAUTION**  
RISK OF ELECTRIC SHOCK  
DO NOT OPEN



CAUTION: TO REDUCE THE RISK OF ELECTRIC SHOCK, DO NOT REMOVE COVER (OR BACK). THERE ARE NO USER-SERVICEABLE PARTS INSIDE. REFER SERVICING TO A QUALIFIED CARDIO THEATER TECHNICIAN.



THIS SYMBOL IS INTENDED TO ALERT THE USER TO THE PRESENCE OF UNINSULATED "DANGEROUS VOLTAGE" WITHIN THE PRODUCT'S ENCLOSURE THAT MAY BE OF SIGNIFICANT MAGNITUDE TO CONSTITUTE A RISK OF ELECTRIC SHOCK TO PERSONS.



THIS SYMBOL IS INTENDED TO ALERT THE USER TO THE PRESENCE OF IMPORTANT OPERATING AND MAINTENANCE INSTRUCTIONS IN THE LITERATURE ACCOMPANYING THE UNIT.

## PVS Universal Stand

- After pulling stand from box, use a torpedo level and a 1/4" hex head wrench to tighten the setscrews. Make sure not to over tighten the setscrews so they don't break the welded square nut.
- Push to combined coax / power cable down the stand through the coped hole at the top. If the cable does not push out freely, you may need to use a grabbing tool to assist the cable out of the stand.
- During shipping the pivot assembly is rotated upside down. Turn the pivot assembly over so that the two mounting hole for the U shaped pivot handle is on the bottom.
- Use a 3/16" hex head wrench to mount the U shaped pivot handle to the pivot point using the provided screws.
- Ensure that the pivoting assembly is tight, but that it allows for the PVS screen to pivot freely.
- Adjust the PVS stand to the machines premium viewing height. The bottom of the screen should be about one inch above the console. Remember to take in consideration the incline of treadmills. Use a tape measure to assure that all like machines are level and at the same height.

## PVS 14.1" LCD Flat Screen

- Carefully place the screen on the stand, and hand start one of the 3mm screws so that the screen is supported.
- Locate the ground cable, and hand start a 3mm screw to the closest to the 12volt input.
- Next, hand start the other two 3mm screws and secure all four tightly. Again make sure that you don't over tighten the screws.
- At this point connect the power and coaxial cables, assuring that the RIGHT and LEFT audio cables are properly connected.
- Use the PO34 voice coupler to connect the screen to the control cable.
- Secure the black cowling to the pivot assembly using the 3mm screws to provide protection for the rear connections.
- Place completed PVS system in front of the cardiovascular machine, making the connection from the power supply to an available 110volt power outlet. Check the cable feed for the proper signal level and make a secure connection.
- Carefully place all excess cables and the power supply inside the PVS stand, securing the cables with the provided end caps.

## PVS MaxJack Controller

- When attaching PVS MaxJack Controller and Control Cable to the cardiovascular machine, take care not to interfere with the normal operation of the equipment.
- If attaching the PVS MaxJack Controller to the control panel of the cardiovascular machine, avoid covering controls or indicators.
- Attach the PVS MaxJack Controller securely with two wire ties and the neoprene-mounting pad provided. You should not be able to rotate the receiver when this properly attached. This is very important to prevent moisture and perspiration from entering the receiver through the headphone jack or power connector on the back of the unit.
- Connect the control cable to the MaxJack Controller and ensure that the access door is secured tightly.

## PVS Programming

- Using the PVS remote control, press the TV/CATV button and make the appropriate selection.
- Press the AUTO MEMORY button and allow the PVS unit to auto program.
- You can use the SKIP button if you need to delete channels that are not appropriate.
- Press the PICTURE SELECT button three times to access the SYSTEM FUNCTIONS menu.
- Press channel down to VIDEO SET. Press volume up to make sure that the DYNAMIC setting has been selected.
- At this time your PVS unit is ready to enjoy.



## PVS CONTROLLER WITH MAXJACK TECHNOLOGY

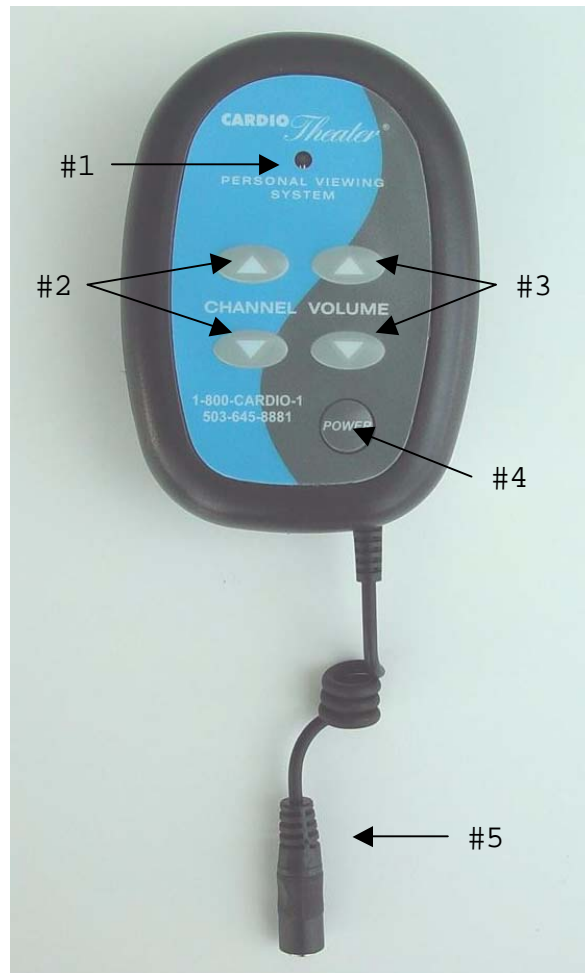

1. IR Sensor – Used only with the PVS Remote Control.
2. Channel Select – To select desired viewing channel.
3. Volume Adjust – To select desired volume level.
4. Power Button – To power the PVS unit on or off.
5. MaxJack Headphone connection – Standard 3.5mm mini headphone jack.

## PVS 14.1" Flat Screen



1. Right side audio input
2. 12V DC input
3. Control line
4. Antenna input
5. Left side audio input
6. Mounting plate

The Upper Monitor can be installed on virtually any piece of equipment.

**Proper placement on the exercise equipment is essential for proper operation and will extend the life of your new product considerably. If you need assistance on locating the proper mounting position on your exercise equipment, please call our Service Center at 1-800-776-6695**

- Remove backing from the self-adhesive mounting pad that is supplied with each Upper Monitor.
- Place the mounting pad on the equipments handrail in a place that will not interfere with normal operation of the equipment and that is out of the “sweat path” of the user.



- Align the Upper Monitor on the previously installed mounting pad (as above).
- Use two of the supplied Plastic Wire Ties to attach the Upper Monitor to the handle or rail. Pull wire ties firmly to secure. Make sure the Upper Monitor can not be rotated. Failure to check this can cause premature failure of the unit.

This method may be used to mount an Upper Monitor either horizontally or vertically.

This is the preferred method of attaching the Upper Monitor to minimize interference with control panels and displays.



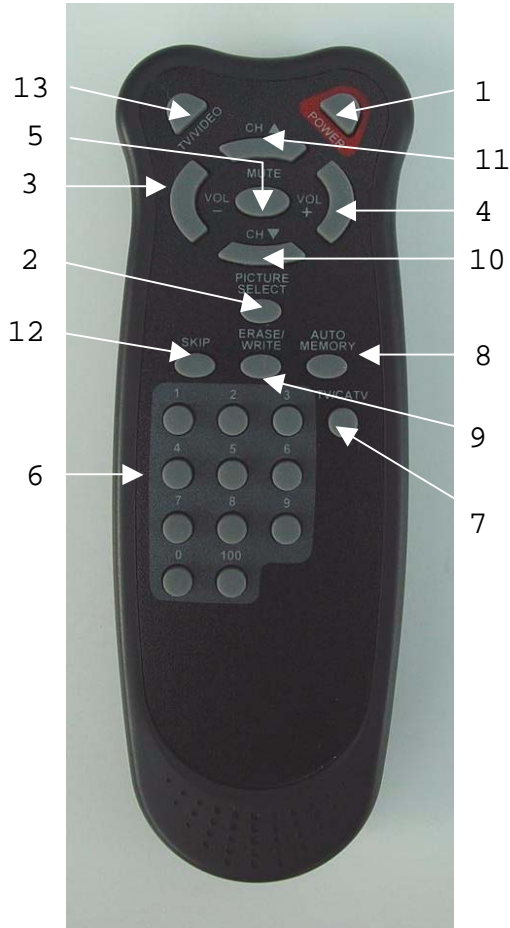

1. POWER ON/STAND BY BUTTON
2. PICTURE SELECT BUTTON
3. VOLUME DOWN BUTTON  
(PICTURE SELECT DOWN)
4. VOLUME UP BUTTON  
(PICTURE SELECT UP)
5. MUTE BUTTON
6. DIRECT ACCESS BUTTON
7. TV/CATV BUTTON
8. AUTO MEMORY BUTTON
9. ERASE/WRITE BUTTON
10. CHANNEL DOWN BUTTON
11. CHANNEL UP BUTTON
12. SKIP BUTTON
13. TV/VIDEO BUTTON

## PVS input levels:

The PVS system requires 0 to 10 db signal input from the cable feed, satellite system, or other RF input. The CVT351A amplifier has an adjustable input attenuator so that the output of the amplifier can be set to 35 db with a signal level meter. With the output of the amplifier set to 35 db, the signal taps shown in the charts will provide the proper input level at each PVS screen. The following tables will show you the various ways that the PVS system can be set up.

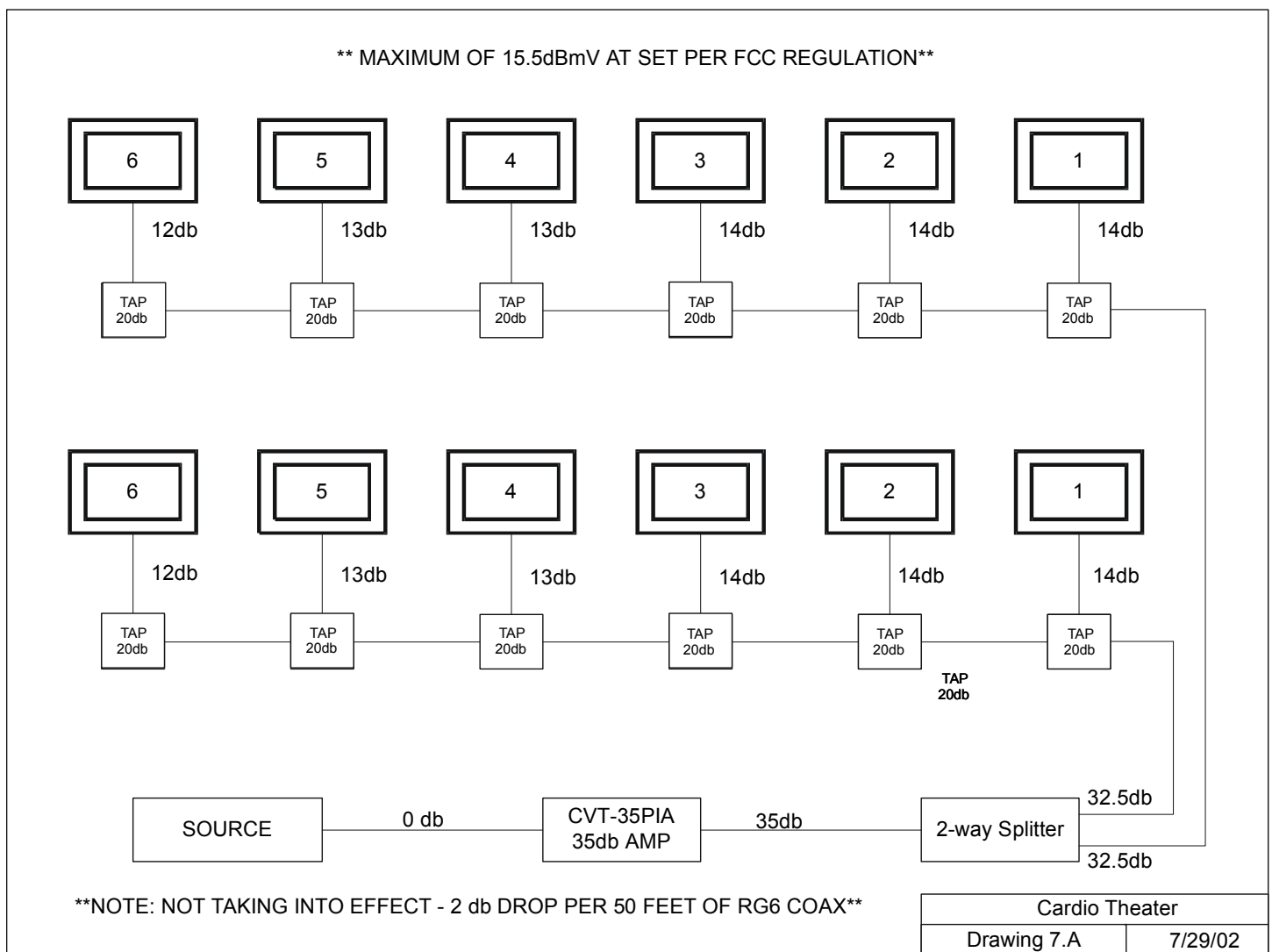

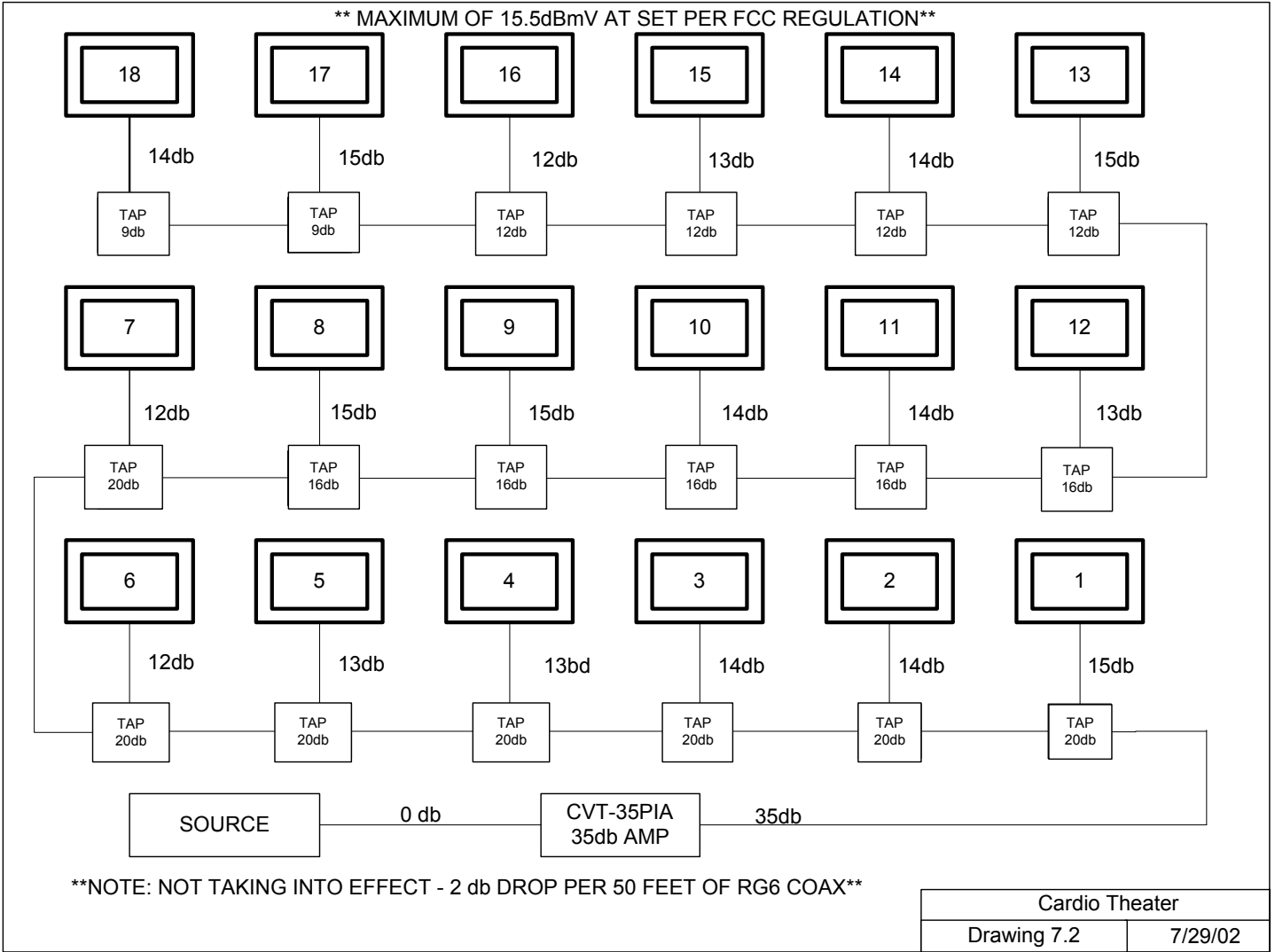

### PVS - Cable Distribution Adding audio sources to cable system

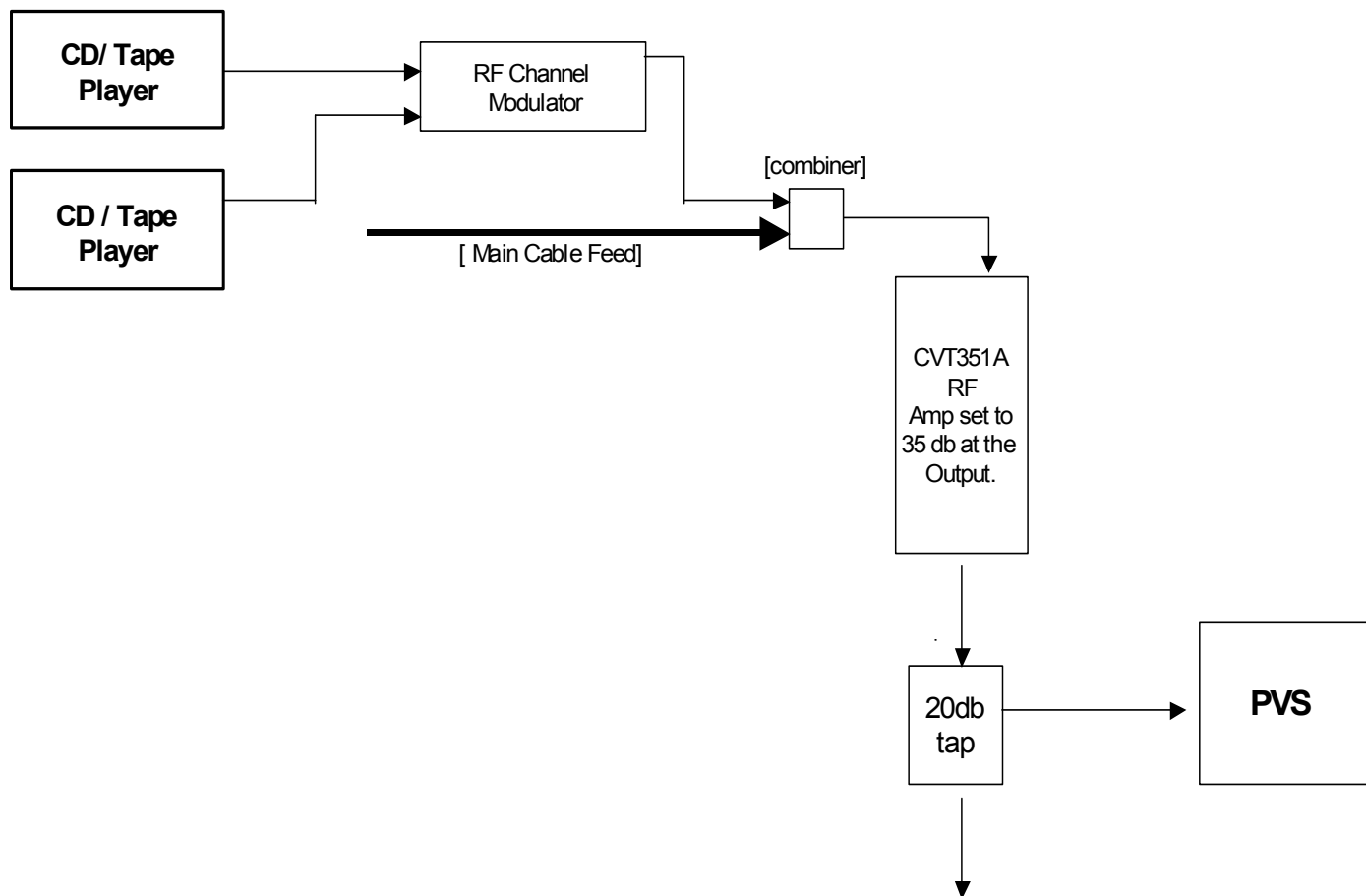

## Regulatory Information

### FCC Compliance and Advisory Statement

This device complies with Part 15 of the FCC Rules. Operation is subject to the following two conditions: 1) this device may not cause harmful interference, and 2) this device must accept any interference received, including interference that may cause undesired operation. This equipment has been tested and found to comply with the limits for a Class B digital device, pursuant to Part 15 of the FCC Rules. These limits are designed to provide reasonable protection against harmful interference in a residential installation.

Any changes or modifications not expressly approved by the party responsible for compliance could void the user's authority to operate the equipment. Where shielded interface cables have been provided with the product or specified additional components or accessories elsewhere defined to be used with the installation of the product, they must be used in order to ensure compliance with FCC regulations.

**Note:** Cardio Theater follows a policy of continuous advancements in development. For this reason, specifications may be changed without notice.

### LCD – 141Q

|                            |  |
|----------------------------|--|
| <b>TYPE</b>                | <b>Color LCD 14" LCD TV Monitor</b>                    |
| <b>DISPLAY SCREEN SIZE</b> | <b>14.1" (W287.5 x H214.3 mm)</b>                      |
| <b>RESOLUTION</b>          | <b>1024(V) x 768(H)</b>                                |
| <b>BACK LIGHT</b>          | <b>Cold cathode fluorescent lamp</b>                   |
| <b>POWER CONSUMPTION</b>   | <b>DC 12V 50W</b>                                      |
| <b>VIDEO SYSTEM</b>        | <b>Auto NTSC/PAL/SECAM</b>                             |
| <b>BRIGHTNESS LEVEL</b>    | <b>300 cd/m2 Typical</b>                               |
| <b>CONTRAST RATIO</b>      | <b>200 Typical for 14.1"</b>                           |
| <b>VIEWING ANGLE</b>       | <b>L/R 50/50 Deg. U/D 20/50 Deg. Typical for 14.1"</b> |
| <b>CONNECTION TERMINAL</b> | <b>"F" Type Cable Connector</b>                        |
| <b>DIMENSIONS</b>          | <b>602x378x212 mm</b>                                  |
| <b>WEIGHT</b>              | <b>550g</b>  |



**Note:** Cardio Theater follows a policy of continuous advancements in development.  
For this reason, specifications may be changed without notice.

**For questions regarding any specifications, please call the Cardio Theater Service Center at (800) 776-6695 or (503) 645-8881.**